

5100

PRIVACY RAIL
SYSTEMS

5100

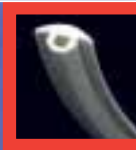

G-RAIL[®]

ALUMINIUM RAIL

> *by Goelst*



Elegant in function and design, G-Rail system 5100 provides a softer round appearance to standard privacy rails whilst still maintaining increased profile strength and usage options. Developed specifically for design lead healthcare projects, beauty therapy classrooms and changing rooms within retail stores etc, system 5100 can be supplied anodised or powder coated to any RAL colour to blend perfectly with contemporary interior colour schemes. Synthetic wall and ceiling fittings allow rail 5100 to comply with the stringent European NEN-3134 standard for special care rooms requiring anti-static facility.

Standard colours: White RAL 9010, natural, brown, gold, silver polished, gold

PRIVACY RAIL SYSTEMS

5100

5100 > The elegant

Installation

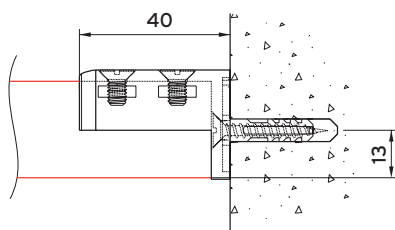

wall fixing with wall support 5150

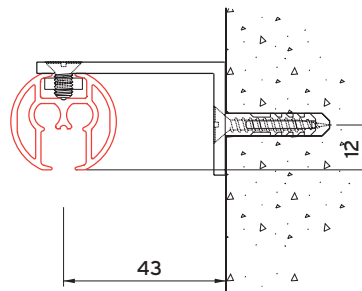

wall fixing with aluminium wall bracket 5141

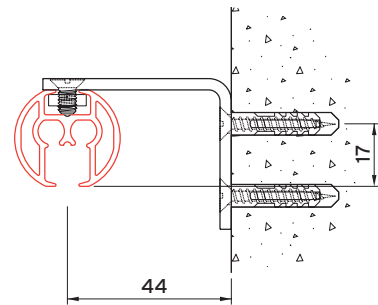

wall fixing with plexiglass wall bracket 5140

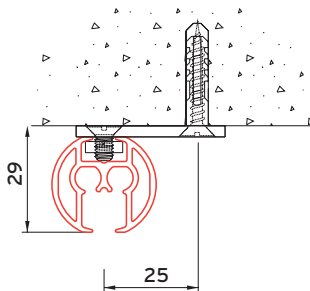

ceiling fixing with ceiling fixing plate 5135

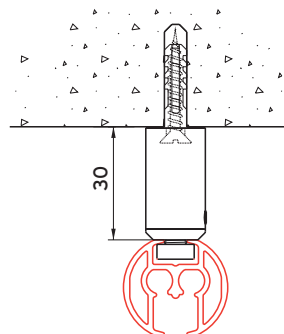

ceiling fixing with mini suspension hanger 4254

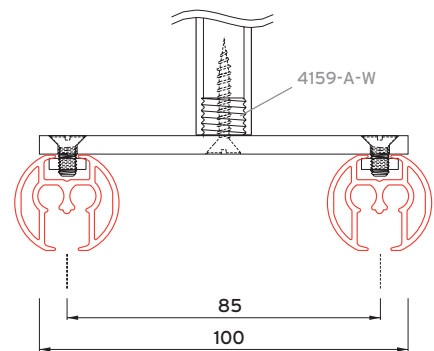

parallel rail fixing with bridging plate 5116-10 and suspension hanger 4155

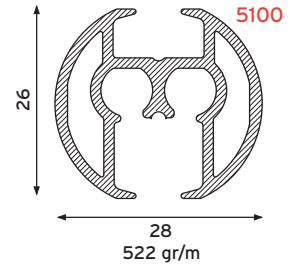

Specification Guide

Material:

Aluminium 606035-T6-F22. (Higher specification than DIN 1725). Shape and size tolerances are in accordance with DIN 17615. Natural silver and gold anodised in accordance with the Qualicoat standard. White RAL 9010 or brown BS08B29 powder coated in accordance with the Qualicoat standard. Special colours available on request. Profile weight: 522 gr/m.

Accessories:

Glider-hooks 4008 (rotating glider with SS hook) at 10 per metre with two end stops 4002 per length. Dust cover 4145 and connecting bridge 5165 to suit.

Installation:

Ceiling fixing with 5135 ceiling fixing plate, 4254 mini suspension hanger, 4155 suspension hanger, 4160 or 4161 V-hanger, 5064 strut-hanger with fixing plate.

Wall fixing with 5150 wall support, 5141 wall bracket or 5140 plexiglass wall bracket.

This system can also be mounted with anti-ligature Load Release components, to provide a controlled system collapse.

and polished. Special colours on request.

ant, round privacy rail.

NEN-3134: Isolated fixing in S3 (anti-static) rooms. Ceiling fixing with suspension hanger 4155 (using synthetic ceiling stud 4156); wall fixing with plexiglass wall bracket 5140 and synthetic wall support 5150. An earth cable needs to be connected.

Bracket distance (cm) in accordance with G-Standard or the following table:

light	medium	heavy	(curtains)
260*)	180*)	120	

*) Please take into account the lateral deflection within the rail. This effect can be reduced by using a V-hanger or strut-hanger with fixing plate.

Bending:

Radius: 15 cm, 25 cm or greater than 1 m. Bending machine 1015.

G-Standard (bracket fixing guide)

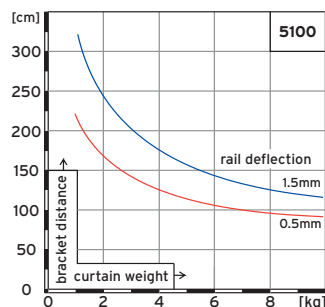

Product example

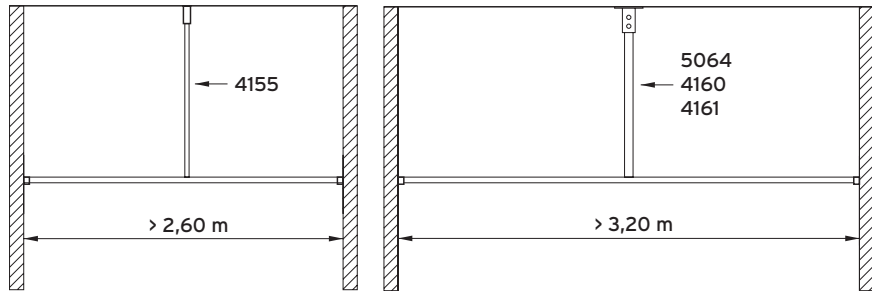

This picture shows when a 'strut-hanger' (5064) or V-hanger (4160/4161) is used and when a vertical suspension hanger (4155) is sufficient.

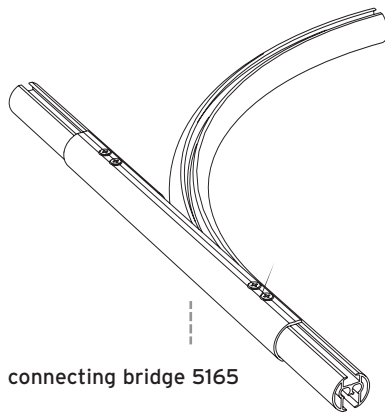

connecting bridge 5165

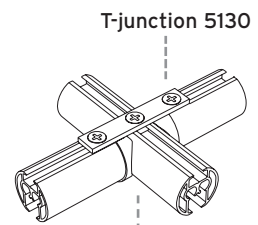

hollow end cap 5153-20



Installation (continuation)

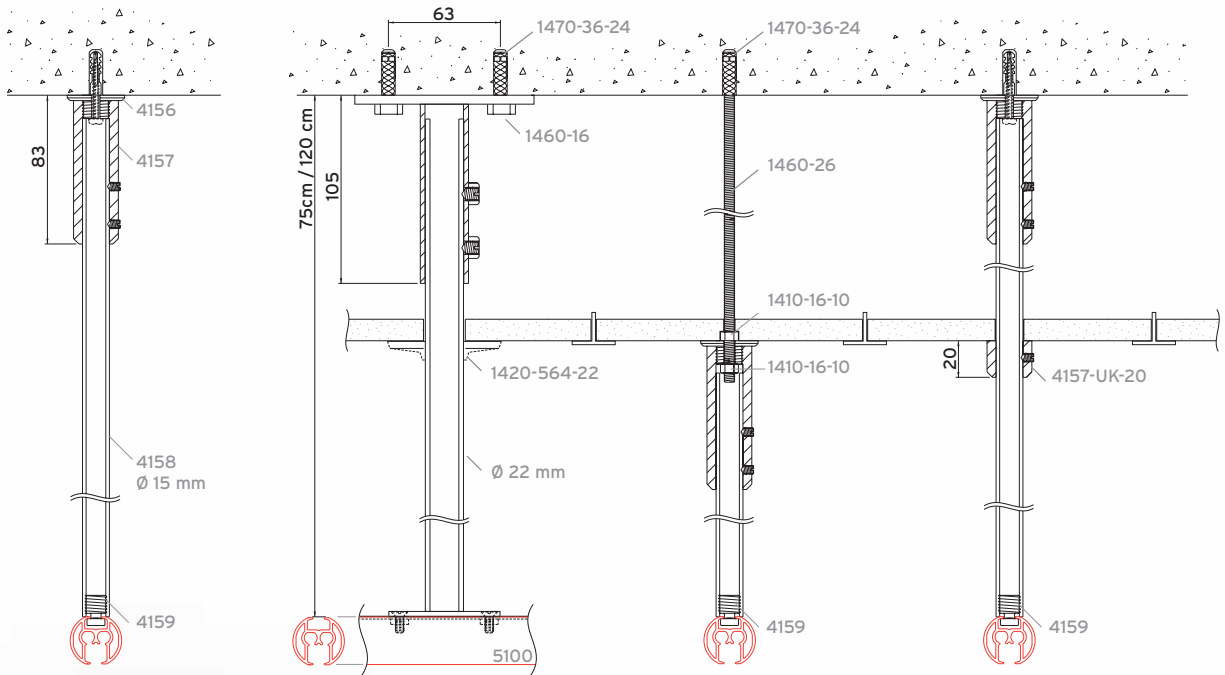

ceiling fixing with suspension hanger 4155

ceiling fixing with strut hanger 5064 through suspended ceiling tiles

ceiling fixing with suspension hanger 4155 and M6 threaded rod through suspended ceiling tiles

ceiling fixing with suspension hanger 4155 through suspended ceiling tiles with dummy ceiling support 4157-UK-20 (or ceiling rose 1420-555-15)

4159: Synthetic thread M12.





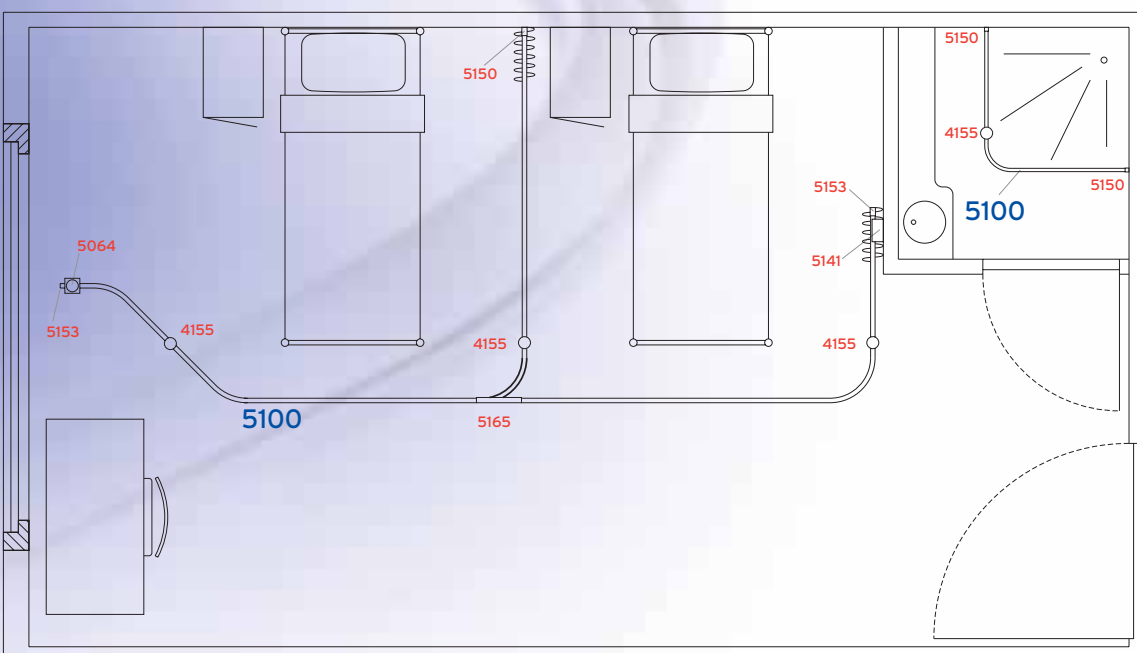





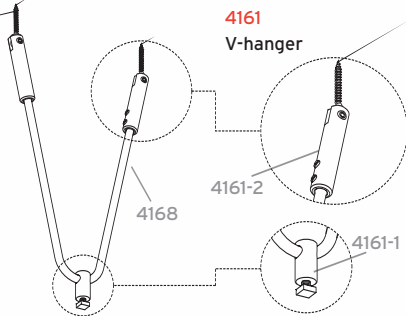
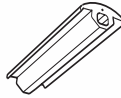

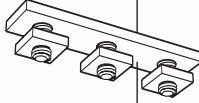



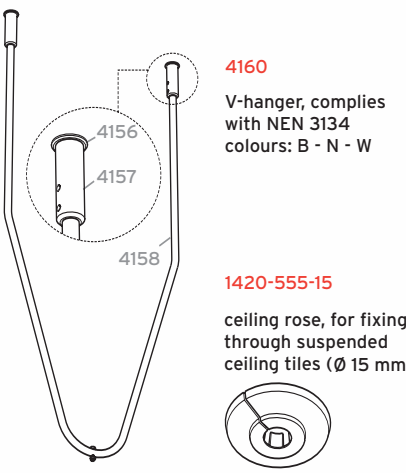

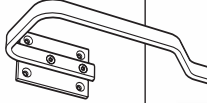

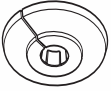
Product example

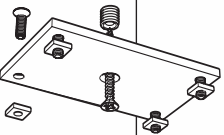
Room example showing system 5100 used in a 2 bed configuration. This detail also shows the use of a 5064 strut hanger where due to the presence of a window wall mounting is not feasible.

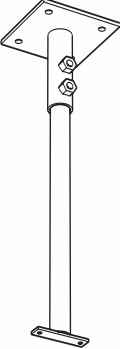

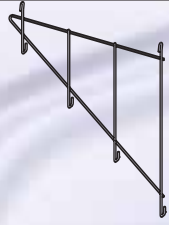
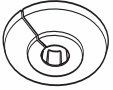
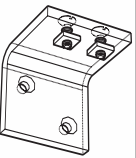
Components

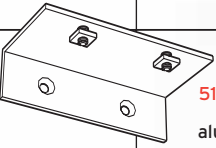
Product design and specification changes reserved.

CURTAIN TRANSPORT				ACCESSORIES		
	4002 end stop		4161 V-hanger		4145 dust cover colours: B - GR - W	
	4003 spring stop		4161-2		5130 T-junction colours: N - W	
	4007 rotating glider not for use with 4180 or 4181 colours: S - W		4161-1		5153 end cap colours: B - G - GR - W - ZW	
	4008 rotating glider 4007 with SS-hook not for use with 4180 or 4181 colours: S - W		4160 V-hanger, complies with NEN 3134 colours: B - N - W		5153-20 end cap hollow in combination with 5130 colours: B - G - GR - W	
	4013 rotating glider with ring (max. 8 kg) for 4180 and 4181 colour: ZW		4156	1420-555-15 ceiling rose, for fixing through suspended ceiling tiles (Ø 15 mm)		4170 curtain holdback with fixing plate colours: N - W
	4007-30 4013 rotating glider with ring (max. 8 kg) for 4180 and 4181 colour: ZW		4157			
CEILING MOUNTING						
	4254 suspension hanger 3 cm colours: B - G - N - W		5116-10 bridging plate with hole 5116-20 : without hole colours: N - W		4181-30 infusion hook 30 cm	
	4155 suspension hanger, complies with NEN 3134 colours: B - G - N - W		5135 ceiling fixing plate colours: N - W		4181-50 infusion hook 50 cm	
	componentry when fixing through suspended ceiling tiles: 1420-555-15 ceiling rose 4157-UK-20 dummy support	WALL MOUNTING				
	5064 strut hanger, inclusive of fixing screws and ceiling rose (scan plate) Ø 22 mm when fixing through suspended ceiling tiles colours: GR - W		5150 wall support		4180 infusion bottle hanger	
	ceiling rose 1420-564-22 (inclusive)		5140 plexiglass wall bracket for mounting in accordance with NEN 3134			5165 connecting bridge colours: B - G - N - W
			5141 aluminium wall bracket colours: N - W		5152 connecting bridge	

PRIVACY RAIL SYSTEMS

5100



5100

B = Brown
G = Gold
GR = Grey
N = Natural
W = White
S = Silver
ZW = Black

▲ = standard item
NEN 3134: see specification guide

G-RAIL®

Space for dealer address

01/2005